

PRODUCT FACT SHEET

VISU WOODBASE CHAIR FURNITURE / LIGHTING / ACCESSORIES

Mika Tolvanen on the design "The task was to create a personal interpretation of the ever-relevant plywood chair. I wanted my chair to have an unobtrusive and timeless nature that is familiar but never boring and without sacrificing function or ergonomics. Designing a family of chairs, visually related but for different functions, was an interactive and thorough process lasting nearly two years. In the end, I think every detail is exactly as it is supposed to be."

PROCESS	Shell is formpressed from wood veneer, then lacquered. If specified, then padded with fire-resitant foam and fully upholstered with textile. Wood base is formpressed in veneer. Upholstered versions with textiles from Kvadrat or leather from Camo.
DESIGNED BY / YEAR OF DESIGN	Mika Tolvanen / 2012
TYPE	Chair
DESCRIPTION	Chair for private or professional interiors available in a range of colours and as well as textile upholstery. Also available with sled base and tube base.
ENVIRONMENT	Indoor
DIMENSIONS (CM)	Height: 78,5 Seat height: 46 Width: 46 Seat width: 42,5 Depth: 51 Seat depth: 40
MATERIAL	Lacquered ash or oak veneer shell, formpressed wood veneer base. Wood is PU lacquered.
COLOUR	Wood shell: Oak, white/oak, black, grey, red, green, dusty green, rose
STANDARD UPHOLSTERIES	Textile: Black/ Field 142, Oak/ Field 232, Oak/ Field 932, Grey/ Steelcut Trio 133, Oak/ Steelcut Trio 515, Black/ Steelcut Trio 195 Leather: Black/Black Silk leather, Oak/Cognac Silk leather Other fabric types for projects available on requests.
CLEANING INSTRUCTIONS	Use moist cloth first, then wipe off excess liquid with dry cloth. For upholstery versions, please find specific cleaning instructions for your chosen textile at www.kvadrat.dk or for leather at www.ca-mo.com
TESTS & CERTIFICATION	Danish Technological Institute - EN 16139 L2. Tested to withstand level 2: Extreme use. Tested to withstand use in areas where the furniture is occasionally or repeatedly subject to extremely high loads. i.e. Nightclubs, railway stations, transport terminals.
SPARE PARTS	Comes with standard glides.
ABOUT THE DESIGNER	Mika Tolvanen is part of the Finnish Rehti Design group. After graduating from the Royal College of Art with a Master in design in 2001, Mika established his own design office in Helsinki. Since then he has worked with some of the world's top designers and manufacturers.

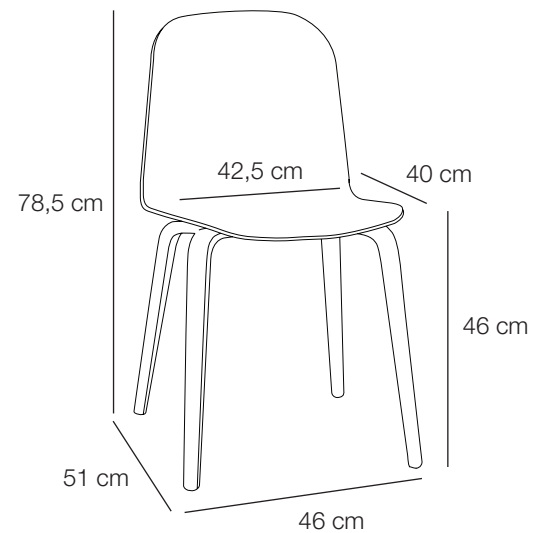

PRODUCT FACT SHEET

VISU SLEDBASE CHAIR FURNITURE / LIGHTING / ACCESSORIES

Mika Tolvanen on the design "The task was to create a personal interpretation of the ever-relevant plywood chair. I wanted my chair to have an unobtrusive and timeless nature that is familiar but never boring and without sacrificing function or ergonomics. Designing a family of chairs, visually related but for different functions, was an interactive and thorough process lasting nearly two years. In the end, I think every detail is exactly as it is supposed to be."

PROCESS	Shell is formpressed from wood veneer, then lacquered. If specified, then padded with fire-resitant foam and fully upholstered with textile. Steel sled base is CNC-bent and powder-coated (coloured versions) or in brushed steel finish. Upholstered versions with textiles from Kvadrat or leather from Camo.	
DESIGNED BY / YEAR OF DESIGN	Mika Tolvanen / 2012	
TYPE	Chair	
DESCRIPTION	Stackable chair for private or professional interiors available in a range of colours and upholsteries. Also available with wood base and tube base.	
ENVIRONMENT	Indoor	
DIMENSIONS (CM)	Height: 78 Width: 53 Depth: 48	Seat height: 45,5 Seat width: 42,5 Seat depth: 40
MATERIAL	Lacquered ash or oak veneer shell, powder coated steel wire base. Wood is PU lacquered. Textile from Kvadrat and leather from Camo.	
COLOUR	Stainless steel/oak, black/black, white/white, grey/grey, dark green/dark green, rose/rose, yellow/yellow	
STANDARD UPHOLSTERIES	Textile: Black/Field 132, Black/Field 142, Grey/Steelcut Trio 133, Black/Steelcut Trio 195 Leather: Black/Black Silk leather, Crome/Cognac Silk leather.	
CLEANING INSTRUCTIONS	Use moist cloth first, then wipe off excess liquid with dry cloth. For upholstery versions, please find specific cleaning instructions for your chosen textile at www.kvadrat.dk or for leather at ca-mo.com	
TESTS & CERTIFICATIONS	Danish Technological Institute - EN 15373 L2. Tested to withstand level 2: Extreme use. Tested to withstand use in areas where the furniture is occasionally or repeatedly subject to extremely high loads. i.e. Nightclubs, railway stations, transport terminals.	
SPARE PARTS	Comes with standard glides. Optional glides with felt can be purchased seperately.	
ABOUT THE DESIGNER	Mika Tolvanen is part of the Finnish Rehti Design group. After graduating from the Royal College of Art with a Master in design in 2001, Mika established his own design office in Helsinki. He has since worked with some of the world's top designers and manufacturers.	

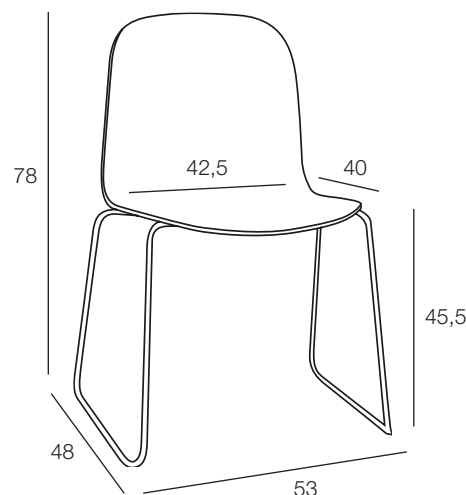

PRODUCT FACT SHEET

VISU TUBE BASE CHAIR FURNITURE / LIGHTING / ACCESSORIES

Mika Tolvanen on the design "The task was to create a personal interpretation of the ever-relevant plywood chair. I wanted my chair to have an unobtrusive and timeless nature that is familiar but never boring and without sacrificing function or ergonomics. Designing a family of chairs, visually related but for different functions, was an iterative and thorough process lasting nearly two years. In the end, I think every detail is exactly as it is supposed to be."

PROCESS	Shell is form pressed from wood veneer, then lacquered. The steel tube base is CNC-bent and powder-coated (coloured version) or in brushed steel finish (chrome version).
DESIGNED BY / YEAR OF DESIGN	Mika Tolvanen / 2014
TYPE	Chair
DESCRIPTION	Stackable chair for private and contract interiors available in a three colours. Visu is also available with sled base or wood base.
ENVIRONMENT	Indoor
DIMENSIONS (CM)	Height: 78 Seat height: 46,5 Width: 44 Seat width: 42,5 Depth: 50 Seat depth: 40
MATERIAL	The shell is either lacquered ash or oak veneer. Steel tube base is powder coated.
SPAREPARTS	Comes with standard glides
COLOUR	Black shell/ black legs, grey shell / grey legs, oak shell / chrome legs
CLEANING INSTRUCTIONS	Use moist cloth first and wipe off excess liquid with dry cloth.
ABOUT THE DESIGNER	Mika Tolvanen is part of the Finnish Rehti Design group. After graduating from the Royal College of Art with a Master in design in 2001, Mika established his own design office in Helsinki. He has since worked with some of the world's top designers and manufacturers.

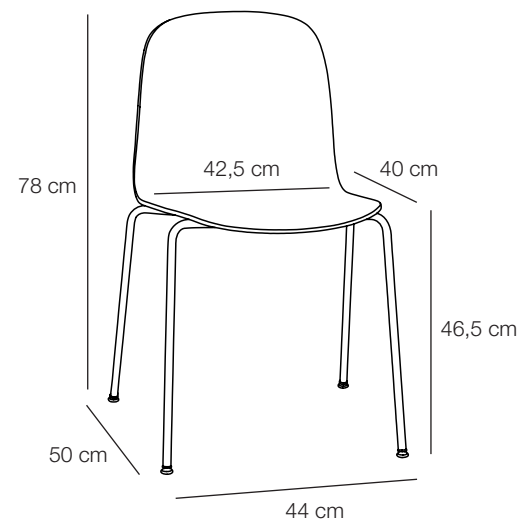





























PRODUCT FACT SHEET

VISU WOOD/SLEDBASE CHAIR FURNITURE / LIGHTING / ACCESSORIES

Standard colours & textiles Other colours or Steelcut Trio textiles are available at a 5% extra cost. Other textiles available upon request.

Colour

Wood shell 	 Grey	 Dusty green	 Green	 Black	 Rose	 Red	 White	 Oak	 Yellow
Wood base 	 Grey	 Dusty green	 Green	 Black	 Rose	 Red	 Oak	 Oak	
Sled base 	 Grey		 Green	 Black	 Rose	 Red	 White	 Stainless steel	 Yellow

Upholstery versions

Upholstered shell 	 Field 132	 Field 142	 Field 232	 Field 932	 Steelcut Trio 133	 Steelcut Trio 515	 Steelcut Trio 195	 Steelcut 190	 Black Silk leather	 Cognac Silk leather
Wood base 		 Black	 Oak	 Oak	 Grey	 Oak		 Black	 Black	 Oak
Sled base 	 Black	 Black			 Grey		 Black		 Black	 Stainless steel